

Luxury Massage Bathtub

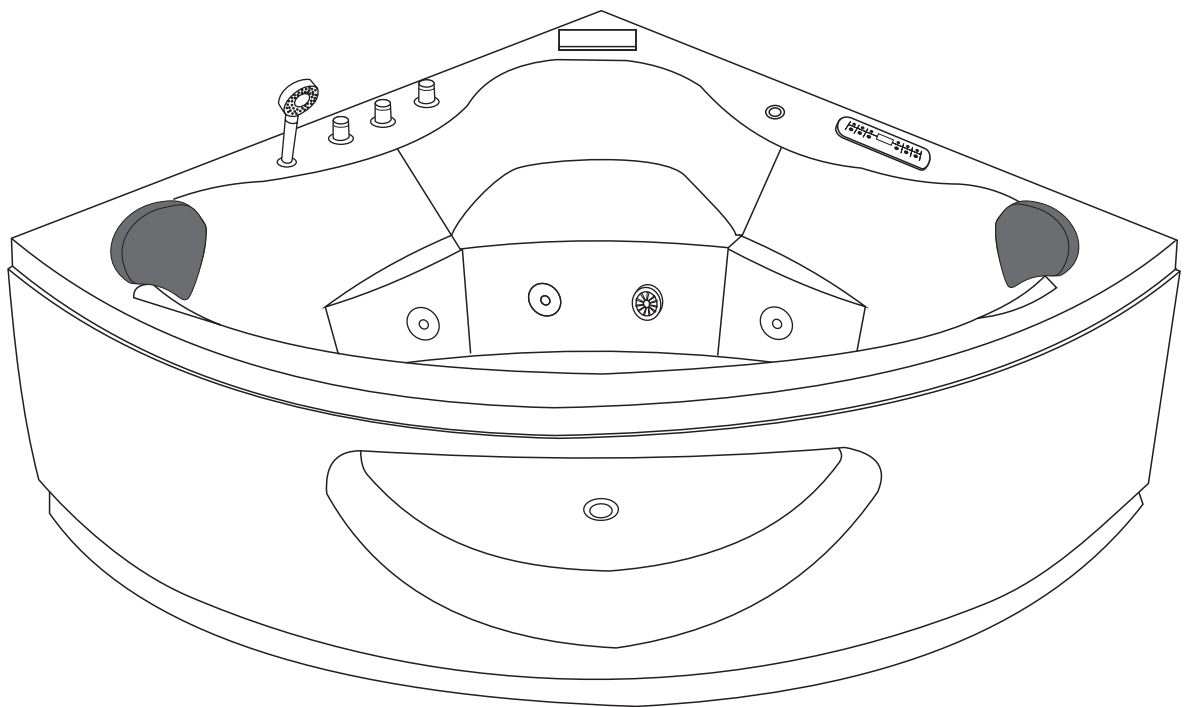

KSM-2512

1400×1400×590

1500×1500×590

Functional Introduction

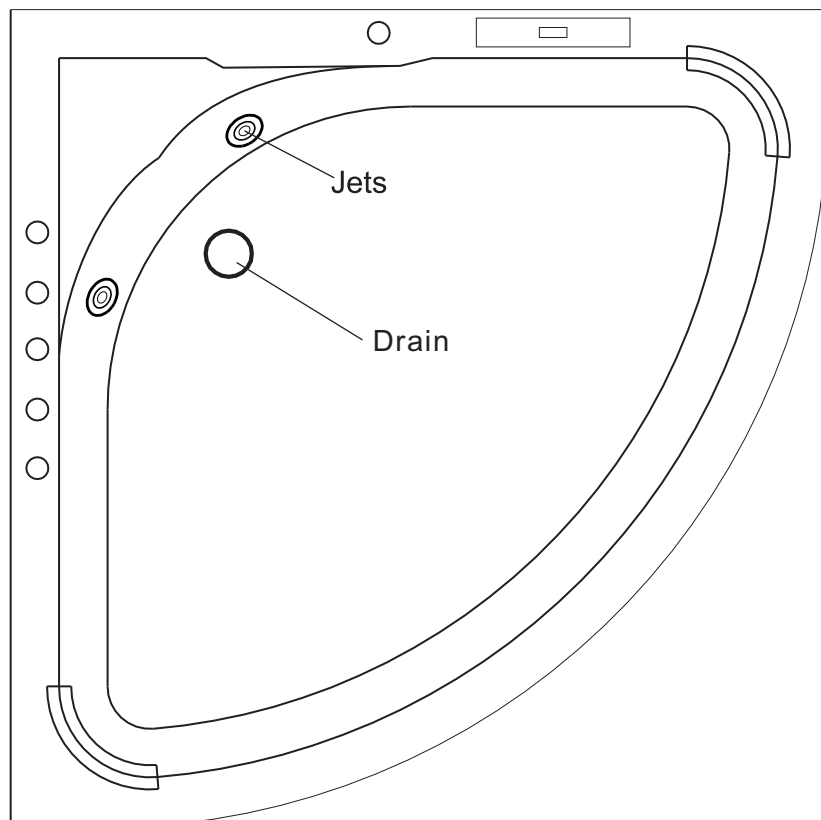
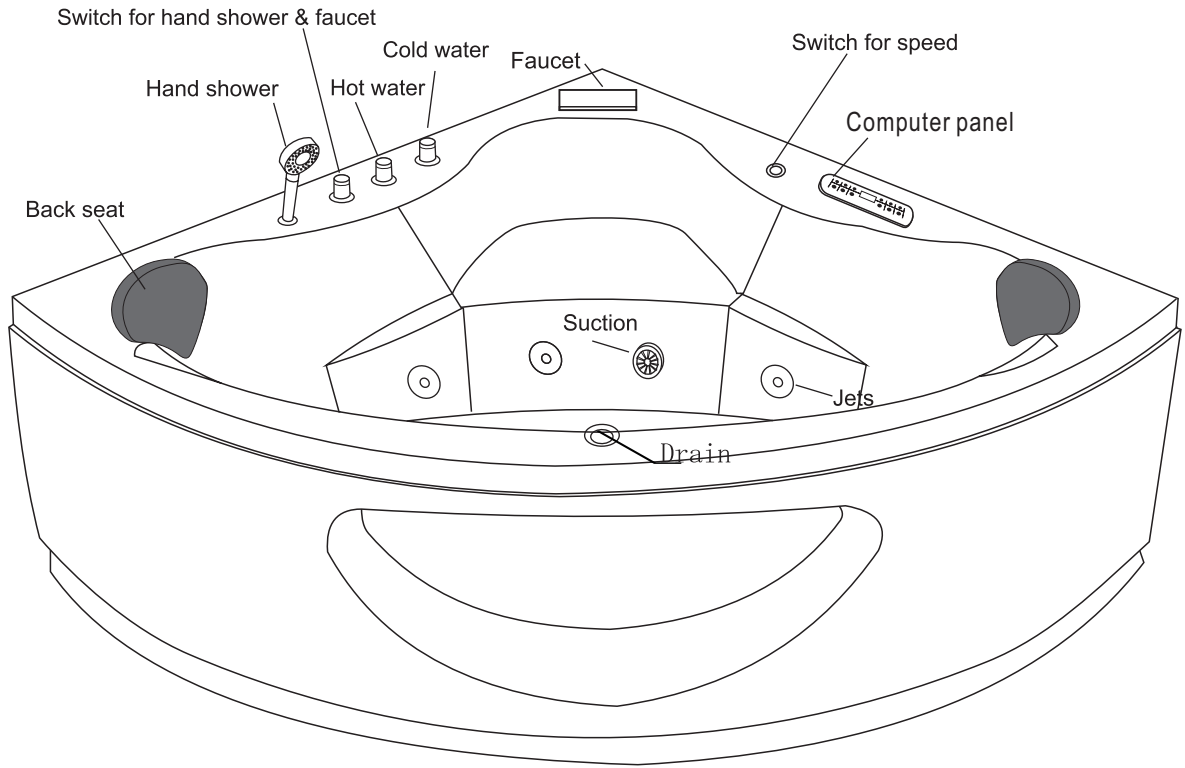

Water & Electricity

Position Design

Length unit: mm

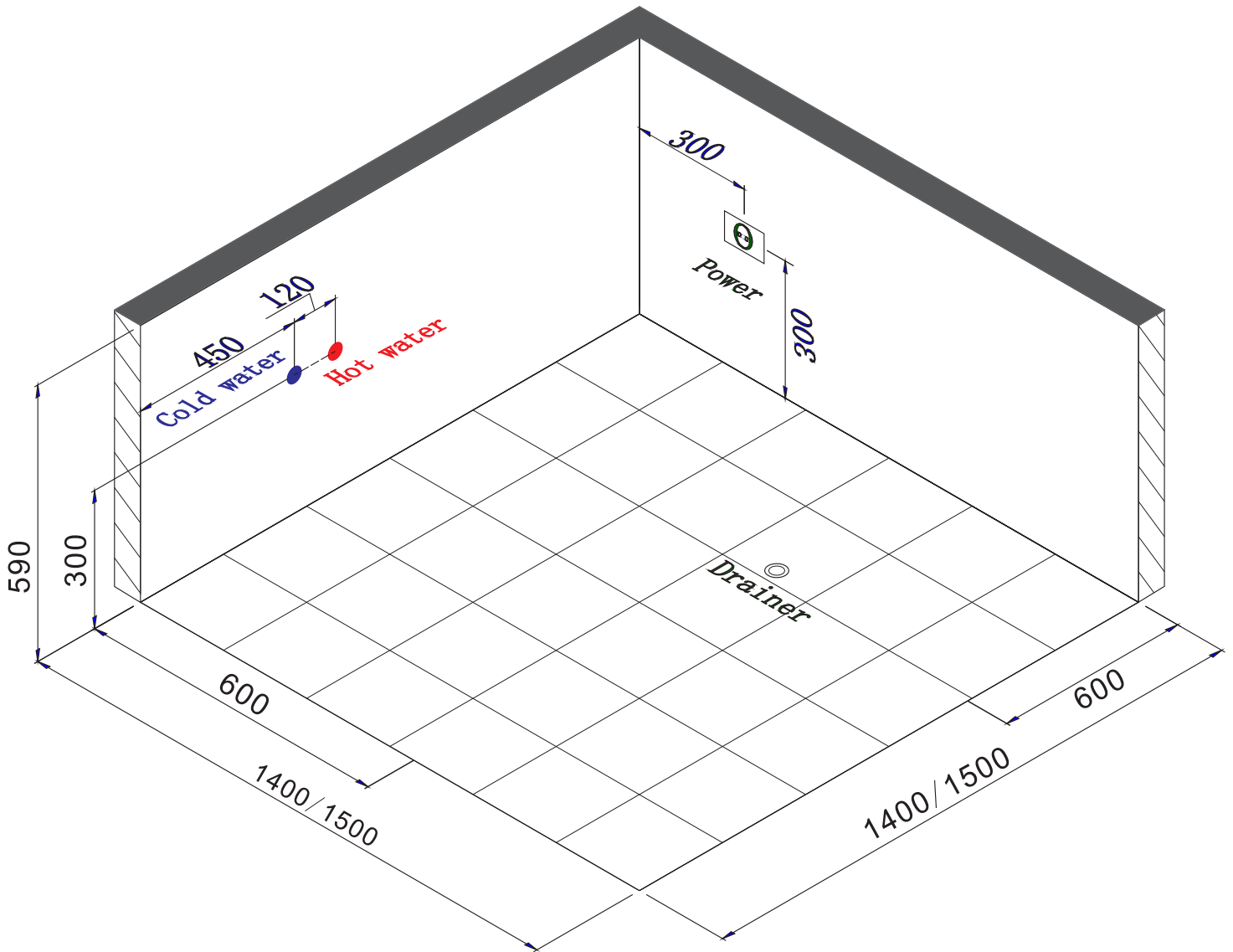



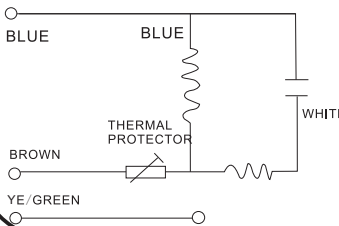

Power Request

DXD PUMP

MODEL DXD-310 A AC 220-240V 50Hz 700W CLASS F IPX5
MAX WATER TEMPERATURE 50°C 15_u F/450V Hmin 1m



BLUE BLUE
BROWN THERMAL PROTECTOR
YE/GREEN WHITE



Ground properly!
Do Not Start Pump
Without Water!

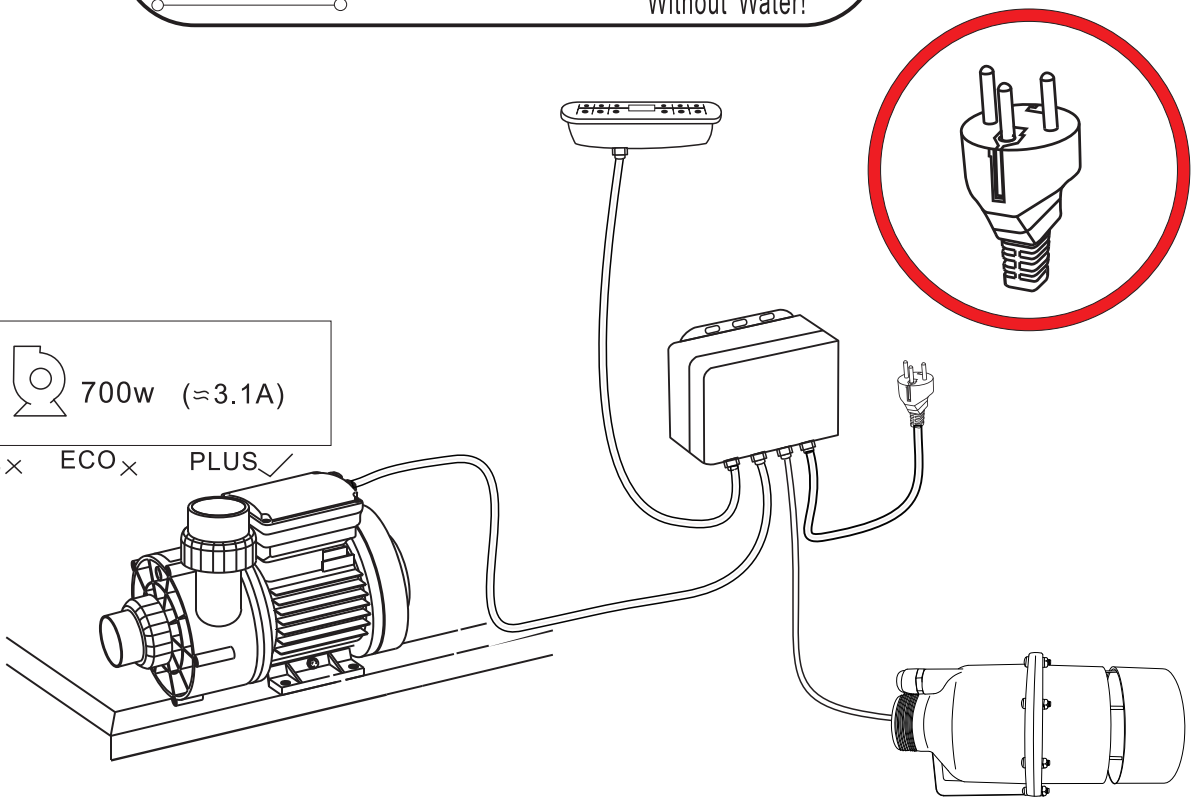

+  700w (≈3.1A)

VITAL~~x~~ ECO~~x~~ PLUS ✓



DXD WIND PUMP

MODEL DXD-6B-350 220-240V 50HZ/60HZ 350W
S1 CLASS 155(F)
IP X5



BAR CODE:

Accessories Installation

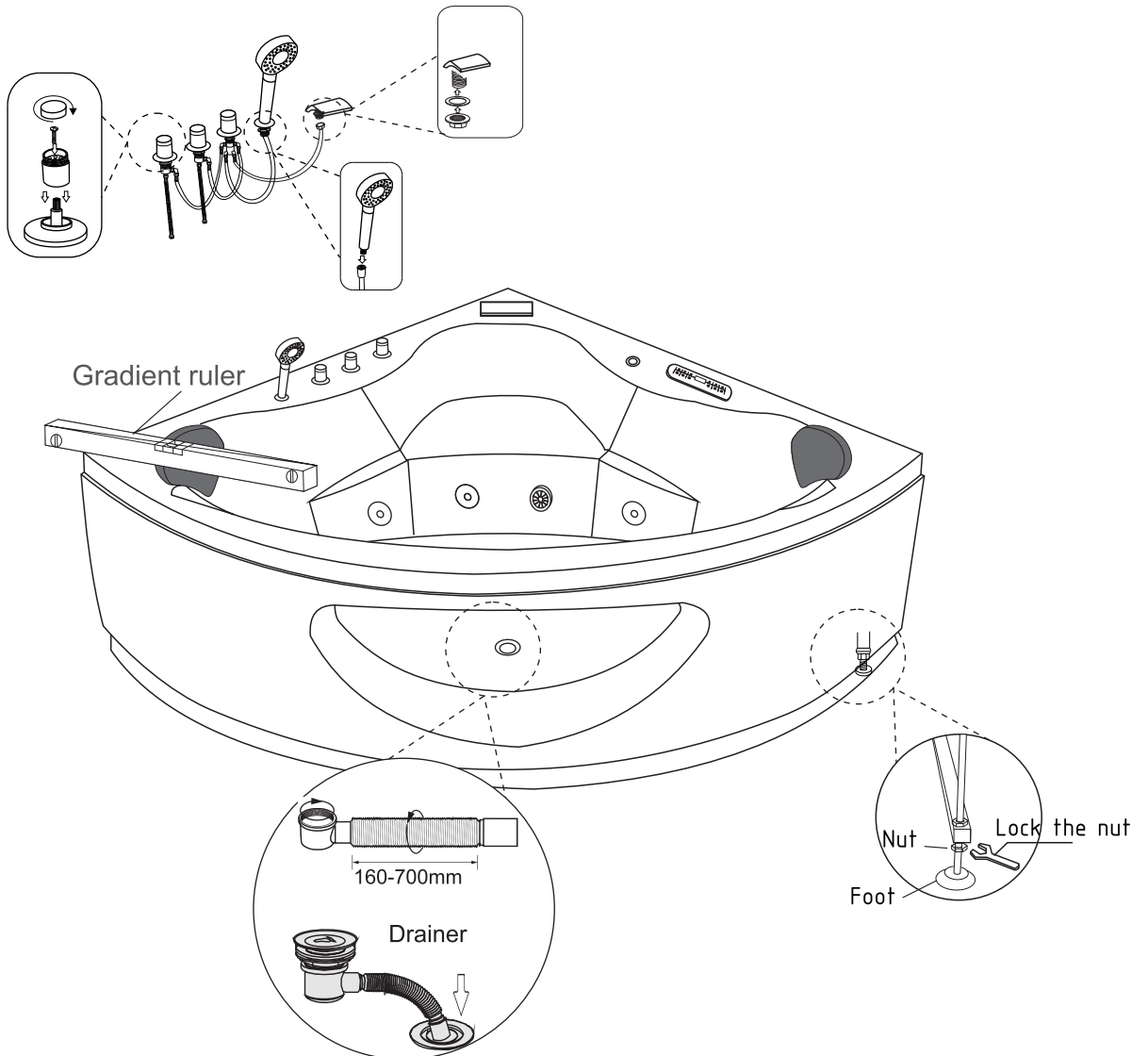
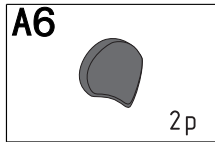
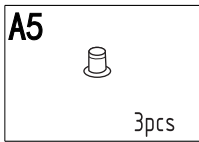
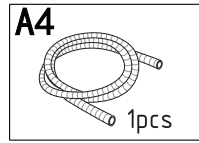
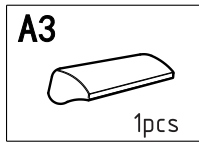
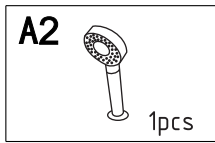
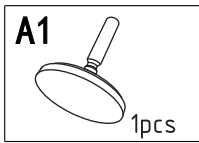
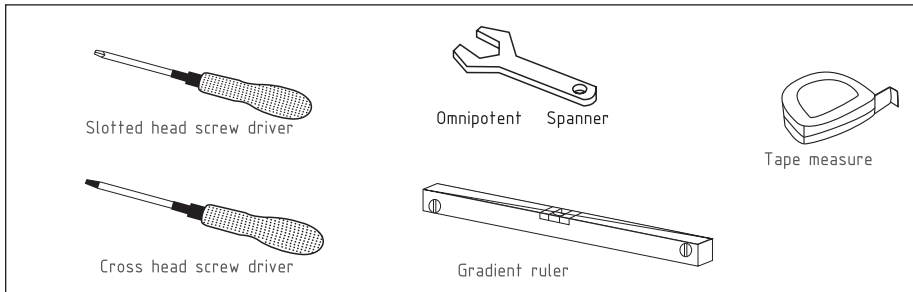

Functional Instructions

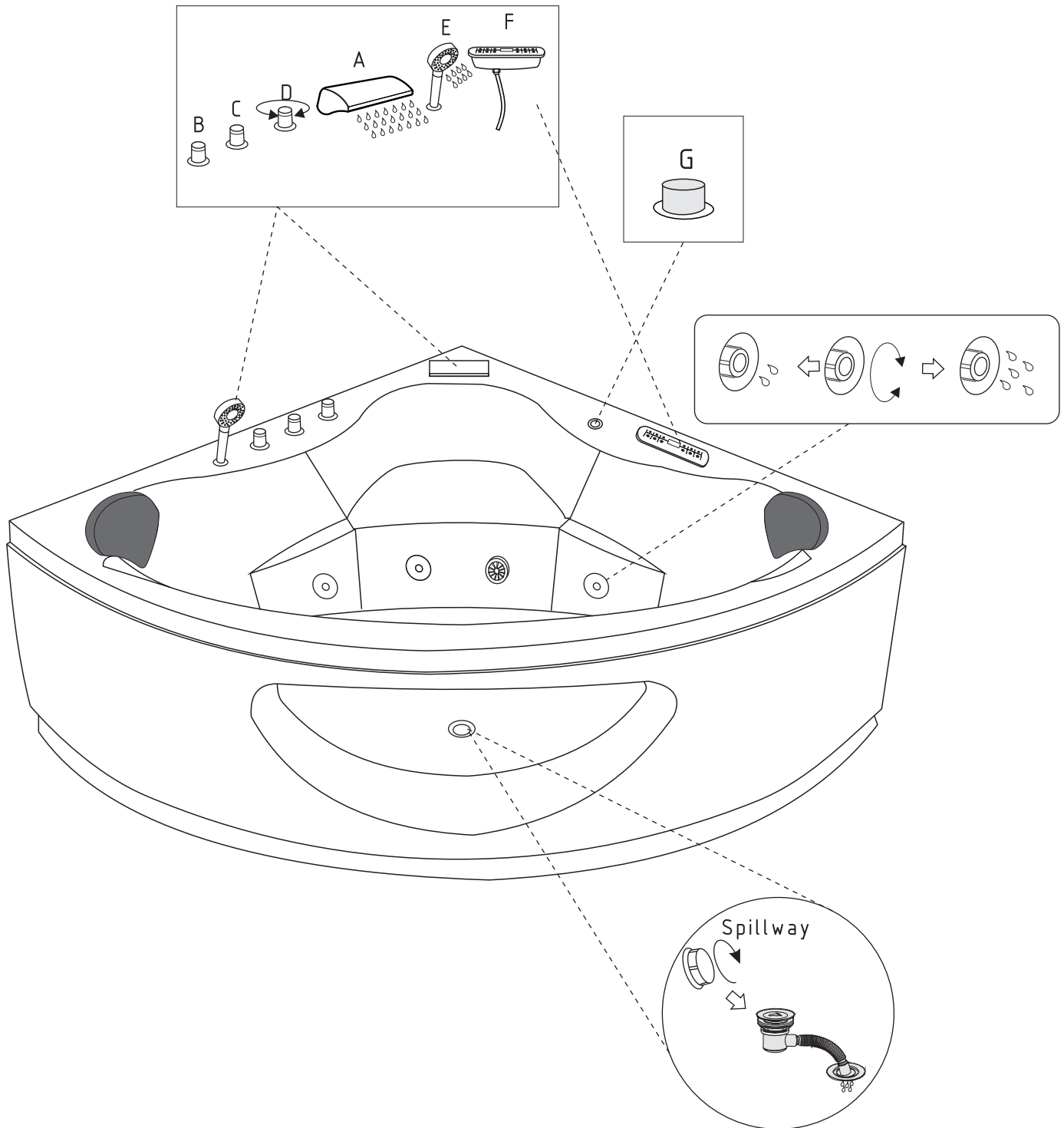

Turn round G, the water runs faster.

Turn round B, cool water.

Turn round C, hot water.

Turn round D, water comes from A or E.

Functional Instructions

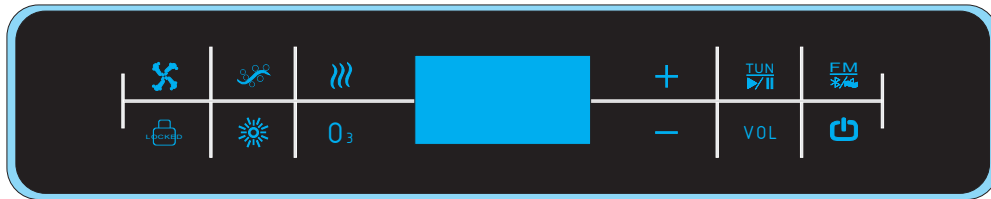

Turn on , the computer panel starts working.

Turn on , the water pump starts working.

Turn on , the air pump starts working.

Turn on , the lights starts working.

This is  lock button. Pressing within 3 seconds to unlock it.

This is  Bluetooth and Radio button.

This is  volume button. Pressing "+" and "-" button to adjust volume.

This is  heater button. Not ordered.

This is  Ozone button. Not ordered.

Warning: do not press water pump button without water.